

SPARTAN SPI-HPFL LED Industrial High Power Flood



- Ultra long life LED
- High lumen output LED
- Easy installation, maintenance and inspection
- Wide operating temperature range of -50° to +50°C
- Extreme durability and toughness
- DALI/Dimming as standard
- 5 year warranty
- Zone 1 & 2 variants available
- Remote power supply variants available (contact Raytec)

The SPARTAN High Power Flood is designed specifically for industrial applications which require high performance, high reliability, White-Light illumination. Specifically, the High Power Flood has been designed to light up large, open areas. The dedicated bracket allows the beam angle to be tilted and easily targeted into the required space. Using Raytec's field-proven, long-life LED technology, SPARTAN High Power Floodlights are suitable for a wide range of industrial applications. SPARTAN High Power Flood has been designed with maintenance in mind. A unique modular design allows key components to be easily accessed and serviced if required, making inspection and maintenance quicker and easier. It also allows for the most flexible installation.

SPARTAN High Power Flood is available in a range of different beam patterns, delivering the ultimate flexibility to specifiers, distributors and end users. SPARTAN uses **COOLEXTRUDE™** thermal management technology, ensuring a much cooler LED operating temperature and up to 60% better heat dissipation compared to traditional lighting solutions, allowing the product to operate for > 10 years while still delivering a high lumen output of up to 25,000 lumens.

Product Dimensions

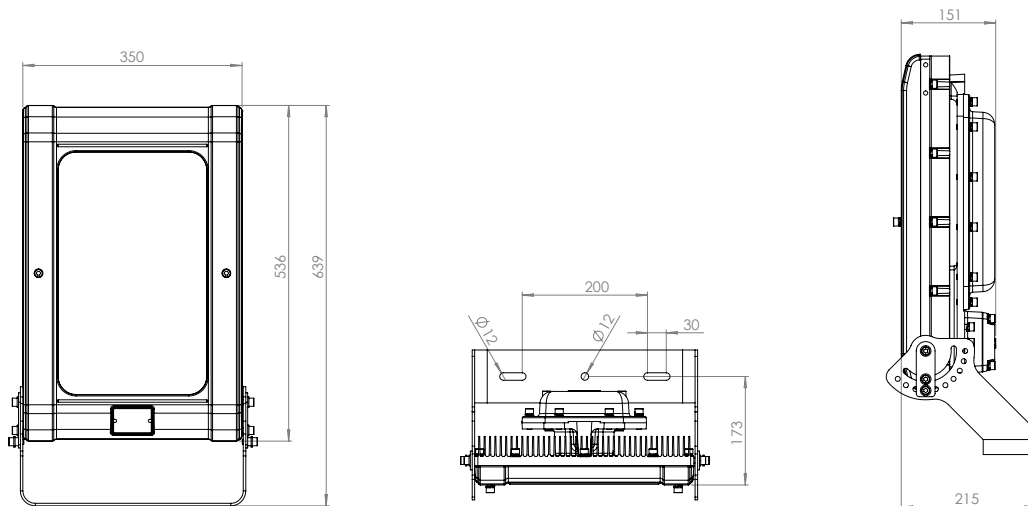

Features

Benefits

Ultra-Powerful	High lumen output - up to 25,000 lumens Latest high power LED technology
Ultra-Flexible	Range of beam patterns available Operating temperature range of -50°C to +50°C for the most challenging conditions
Ultra-Reliable	Industry leading 5 year warranty Designed and manufactured in the UK to the highest standards including both ISO9001 & ISO14001 Advanced electronics and LEDs Extreme durability and toughness
Ultra-Modular	Both the LED and PSU modules are easily accessible for maintenance and inspection
Ultra-Efficient	COOLEXTRUDE™ thermal management delivers class leading energy efficiency Significant running and maintenance savings compared to traditional lighting technologies SMART access wiring system for safe and efficient installation, set-up and ongoing inspection
Ultra-Support	Photometric files available (.ies & .ldt) Full Lighting Design Service Site specific Energy and Cost Saving Report available

5 YEAR WARRANTY

All Raytec luminaires are provided with an industry leading 5 year warranty and have an expected useful life in excess of 10 years



Technical Specifications

Electrical

Input:	110-277V 50/60Hz AC only
Power:	120W – 10,000lm 180W – 15,000lm 240W – 20,000lm 300W – 25,000lm
Termination	Incoming terminal block suitable for looping 3 core 4mm ² cable
Power Factor:	>0.95
Cable Entries	2xM20 as standard (other entries available upon request)

Optical

Beam Patterns-circular:	30°x 30° or 60°x 60° or 90°x 90°
Lumen output on mains:	Up to 25,000 lumens
LED type:	Platinum Elite SMT LEDs
Number of LEDs:	12 or 24
CRI	80+
Colour Temperature:	5,000K
Automatic Thermal Cutback Feature	Refer to the graph below

Mechanical/Environmental

Burning position:	Universal
IP rating:	IP66 & IP67
Temperature range:	-50°C to +50°C
Weight:	23.5kg (51.8lbs)
Enclosure:	Marine grade aluminium epoxy powder coated, toughened glass, all external fasteners and brackets are marine grade stainless steel
Unit Colour:	Front - White (RAL 9016) Back - Silver (RAL 9006)
Installation instructions:	Please contact Raytec for copy
Dimensions:	639 x 350 x 215mm (25.2 x 13.8 x 8.5")
Mounting:	Stirrup bracket (see dimension drawings on Page 2)

Automatic Thermal Cutback Feature

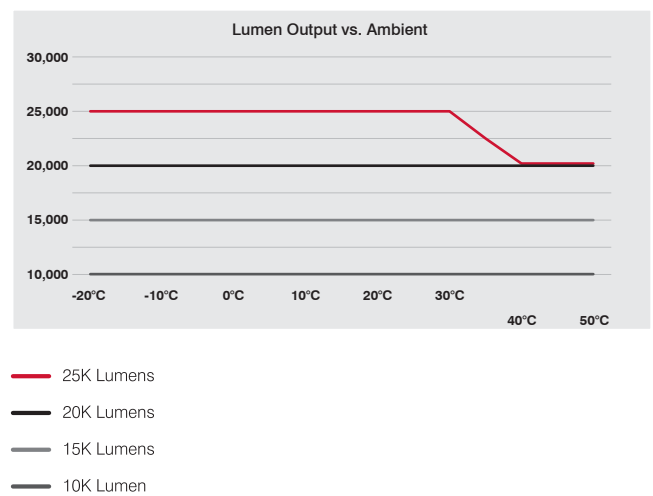

Product Codes - Industrial

Part Codes (Select beam pattern below to replace 'XXXX')	Description
SPI-HPFL25K-W-XXXX	SPARTAN High Power Flood, Industrial, White-Light, 25,000lm
SPI-HPFL20K-W-XXXX	SPARTAN High Power Flood, Industrial, White-Light, 20,000lm
SPI-HPFL15K-W-XXXX	SPARTAN High Power Flood, Industrial, White-Light, 15,000lm
SPI-HPFL10K-W-XXXX	SPARTAN High Power Flood, Industrial, White-Light, 10,000lm

Beam pattern

3030	Circular beam pattern, 30° x 30° beam
6060	Circular beam pattern, 60° x 60° beam
9090	Circular beam pattern, 90° x 90° beam

Beam patterns - Circular

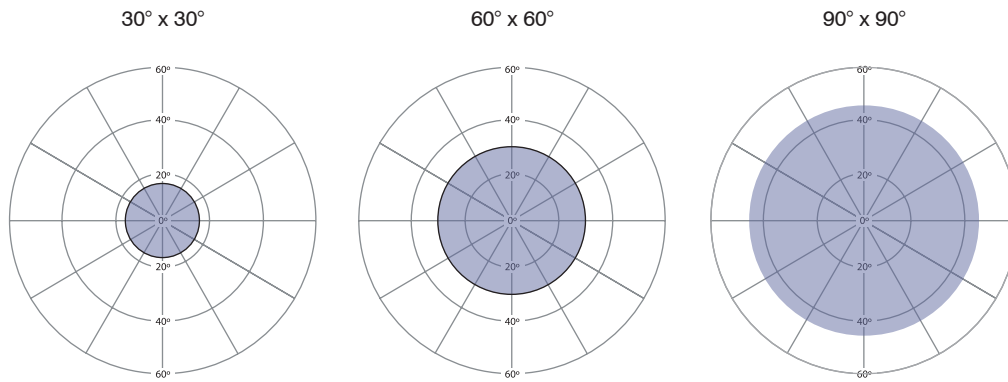

Products in the SPARTAN High Power Flood range

Zone 1, Zone 2, UL/CSA, Industrial

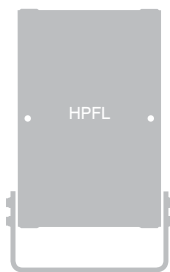

Products in the SPARTAN Family

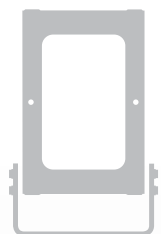

SPARTAN Flood



SPARTAN Linear

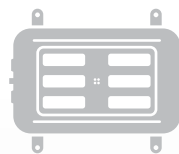

SPARTAN Bulkhead



SPARTAN Bay

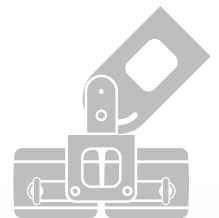

SPARTAN Crane